

PIP 80, 100, 125

(Plastic Irrigation Pipe)

Gasketed Fittings

NACO Industries certifies that our PIP (Plastic Irrigation Pipe) PVC (Poly Vinyl Chloride) Fittings meet or exceed applicable ASAE and ASTM standards, and/or materials used in the manufacturing process meet or exceed applicable ASAE and ASTM standards. For a list of these standards, please contact our corporate office.

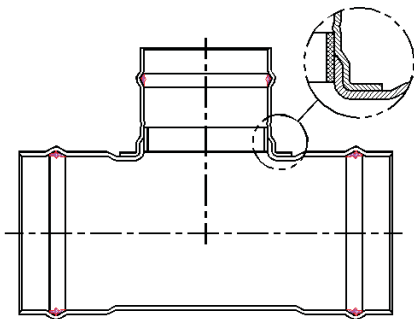

You will find our Triple Wall Design on all Fabricated Pressure Rated Tees. Provides the greatest hoop strength to the critical branch area of a fabricated tee.



NACO Industries
 395 West 1400 North
 Logan, UT 84341
 Phone 435-753-8020
 Toll Free 800-445-4151
 Fax 435-752-7041
 (Corporate)

Before installing any PVC piping or fitting product, you should consult a qualified Project Engineer with experience designing PVC piping, and/or drainage systems. NACO Industries does not assume the responsibility of the Engineer. DO NOT use NACO Industries' fittings to transport or store compressed air or gases, or test thermoplastic piping systems with compressed air or gases.

NACO Industries, a Division of Heritage Products Group, Inc.



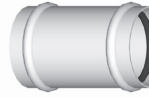



PIP 80, 100 & 125 Gasketed

Item:	Size:	Part Number:	List Price:	Part Number:	List Price:	Part Number:	List Price:
Coupler w/ Center Stop Gasket x Gasket							
 30" & 36" are CIOD		80 PSI		100 PSI		125 PSI	
	6			2924-0602	\$51.72	3024-0602	\$67.85
	8			2924-0802	\$85.05	3024-0802	\$111.34
	10	2824-1002	\$94.26	2924-1002	\$122.09	3024-1002	\$164.26
	12	2824-1202	\$136.79	2924-1202	\$151.48	3024-1202	\$217.91
	15	2824-1502	\$220.29	2924-1502	\$328.53	3024-1502	\$348.96
	18.7	2824-1872	\$367.95	2924-1872	\$388.02	3024-1872	\$508.32
	21	2824-2102	\$459.94	2924-2102	\$627.31	3024-2102	\$735.67
	24	2824-2402	\$690.75	2924-2402	\$836.74	3024-2402	\$1,045.92
	27	2824-2702	\$891.22	2924-2702	\$1,010.08	3024-2702	\$1,308.04
	30			6424-3002	Call		
36			6424-3602	Call			
Repair Coupler w/o Center Stop Gasket x Gasket							
 30" & 36" are CIOD		80 PSI		100 PSI		125 PSI	
	6			2925-0602	\$71.56	3025-0602	\$93.03
	8			2925-0802	\$101.43	3025-0802	\$131.86
	10	2825-1002	\$152.43	2925-1002	\$162.71	3025-1002	\$211.52
	12	2825-1202	\$211.46	2925-1202	\$223.28	3025-1202	\$290.27
	15	2825-1502	\$316.70	2925-1502	\$332.47	3025-1502	\$432.22
	18.7	2825-1872	\$527.44	2925-1872	\$608.32	3025-1872	\$790.81
	21	2825-2102	\$729.34	2925-2102	\$973.06	3025-2102	\$1,264.97
	24	2825-2402	\$1,013.07	2925-2402	\$1,215.93	3025-2402	\$1,580.71
	27	2825-2702	\$1,296.80	2925-2702	\$1,620.68	3025-2702	\$2,106.89
	30			6425-3002	Call		
36			6425-3602	Call			
Adapter Gasket x Spigot							
 30" & 36" are CIOD		80 PSI		100 PSI		125 PSI	
	6			2919-06023	\$40.97	3019-06023	\$51.84
	8			2919-08023	\$63.44	3019-08023	\$82.54
	10	2819-10023	\$87.45	2919-10023	\$92.83	3019-10023	\$122.57
	12	2819-12023	\$107.63	2919-12023	\$126.16	3019-12023	\$161.16
	15	2819-15023	\$166.41	2919-15023	\$250.92	3019-15023	\$292.57
	18.7	2819-18723	\$279.43	2919-18723	\$340.59	3019-18723	\$385.03
	21	2819-21023	\$408.69	2919-21023	\$504.86	3019-21023	\$586.70
	24	2819-24023	\$507.01	2919-24023	\$781.60	3019-24023	\$669.60
	27	2819-27023	\$648.46	2919-27023	\$810.34	3019-27023	\$1,013.07
	30			6419-30023	Call		
36			6419-36023	Call			
End Cap x Gasket							
 30" & 36" are CIOD		80 PSI		100 PSI		125 PSI	
	6			2947-0602	\$73.47	3047-0602	\$82.07
	8			2947-0802	\$108.11	3047-0802	\$130.21
	10			2947-1002	\$174.42	3047-1002	\$203.68
	12			2947-1202	\$233.68	3047-1202	\$293.64
	15			2947-1502	\$335.46	3047-1502	\$474.52
	18.7			2947-1872	\$630.78	3047-1872	\$770.56
	21			2947-2102	\$913.32	3047-2102	\$1,221.18
	24			2947-2402	\$1,278.05	3047-2402	\$1,546.37
	27			2947-2702	\$1,428.82	3047-2702	\$1,627.73
	30			6447-3002	Call		
36			6447-3602	Call			

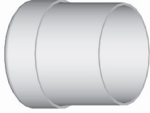

PIP 80, 100 & 125 Gasketed

Item:	Size:	Part Number:	List Price:	Part Number:	List Price:	Part Number:	List Price:
End Plug Cap x Spigot							
 30" & 36" are CIOD		80 PSI		100 PSI		125 PSI	
	6			2948-0603	\$29.62	3048-0603	\$40.14
	8			2948-0803	\$73.11	3048-0803	\$96.77
	10			2948-1003	\$118.27	3048-1003	\$155.19
	12			2948-1203	\$137.38	3048-1203	\$180.75
	15			2948-1503	\$229.49	3048-1503	\$301.29
	18.7			2948-1873	\$326.97	3048-1873	\$429.12
	21			2948-2103	\$497.34	3048-2103	\$653.72
	24			2948-2403	\$622.54	3048-2403	\$821.69
	27			2948-2703	\$795.52	3048-2703	\$1,028.00
	30			6448-3002	Call		
36			6448-3602	Call			
Expansion Joint Coupler Gasket x Soc							
 30" & 36" are CIOD (Overall Length is 31")		80 PSI		100 PSI		125 PSI	
	6 x 31			2927-06021	\$81.72	3027-06021	\$106.23
	8 x 31			2927-08021	\$121.86	3027-08021	\$158.41
	10 x 31			2927-10021	\$162.71	3027-10021	\$211.52
	12 x 31			2927-12021	\$202.73	3027-12021	\$263.55
	15 x 31			2927-15021	\$283.73	3027-15021	\$368.85
	18.7 x 31			2927-18721	\$375.24	3027-18721	\$487.82
	21 x 31			2927-21021	\$519.94	3027-21021	\$584.25
	24 x 31			2927-24021	\$641.25	3027-24021	\$736.50
	27 x 31			2927-27021	\$836.30	3027-27021	\$1,022.56
	30 x 31			6427-30021	Call		
36 x 31			6427-36021	Call			
Expansion Joint Coupler Gasket x Soc							
 30" & 36" are CIOD (Overall Length is 48")		80 PSI		100 PSI		125 PSI	
	6 x 48			2927-06021-48	\$122.58	3027-06021-48	\$159.34
	8 x 48			2927-08021-48	\$182.79	3027-08021-48	\$237.61
	10 x 48			2927-10021-48	\$244.07	3027-10021-48	\$317.28
	12 x 48			2927-12021-48	\$304.09	3027-12021-48	\$395.32
	15 x 48			2927-15021-48	\$425.60	3027-15021-48	\$553.27
	18.7 x 48			2927-18721-48	\$562.86	3027-18721-48	\$731.73
	21 x 48			2927-21021-48	\$779.91	3027-21021-48	\$876.37
	24 x 48			2927-24021-48	\$961.88	3027-24021-48	\$1,104.75
	27 x 48			2927-27021-48	\$1,254.09	3027-27021-48	\$1,533.84
	30			6427-30021-48	Call		
36			6427-36021-48	Call			
Coupler PIP Gasket x IPS Gasket							
		80 PSI		100 PSI		125 PSI	
	6			2924-0602i	\$60.32	3024-0602i	\$76.22
	8			2924-0802i	\$82.07	3024-0802i	\$104.53
	10			2924-1002i	\$119.94	3024-1002i	\$152.43
	12			2924-1202i	\$199.74	3024-1202i	\$253.86
	15 x 12			2924-7322i	\$324.59	3024-7322i	\$405.59





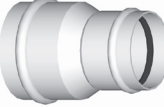
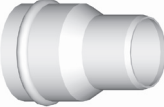
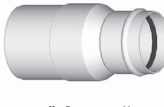

PIP 80, 100 & 125 Gasketed

Item:	Size:	Part Number:	List Price:	Part Number:	List Price:	Part Number:	List Price:
Reducer Gasket x Gasket							
 4" & smaller outlets are IPS 30" & 36" are CIOD		80 PSI		100 PSI		125 PSI	
	6 x 4			2932-5322	\$75.86	3032-5322	\$97.84
	8 x 4			2932-5822	\$111.57	3032-5822	\$148.25
	8 x 6			2932-5852	\$99.87	3032-5852	\$126.27
	10 x 6			2932-6262	\$185.29	3032-6262	\$231.64
	10 x 8	2832-6282	\$142.88	2932-6282	\$160.20	3032-6282	\$203.68
	12 x 8			2932-6682	\$255.65	3032-6682	\$308.10
	12 x 10	2832-6702	\$193.41	2932-6702	\$219.81	3032-6702	\$280.99
	15 x 10			2932-7302	\$392.32	3032-7302	\$491.01
	15 x 12	2832-7322	\$284.93	2932-7322	\$319.69	3032-7322	\$399.49
	18.7 x 12			2932-3772	\$622.54	3032-3772	\$745.71
	18.7 x 15	2832-3792	\$509.16	2932-3792	\$558.86	3032-3792	\$638.67
	21 x 15			2932-8552	\$979.03	3032-8552	\$1,224.17
	21 x 18.7	2832-8592	\$778.10	2932-8592	\$878.55	3032-8592	\$977.72
	24 x 18.7			2932-9192	\$1,620.33	3032-9192	\$2,014.57
	24 x 21	2832-9212	\$1,322.97	2932-9212	\$1,473.02	3032-9212	\$1,831.42
	27 x 24	2832-9482	\$1,668.71	2932-9482	\$1,851.96	3032-9482	\$2,360.30
	30 x 24			6432-9702p	Call		
	30 x 27			6432-9712p	Call		
	36 x 24			6432-9882p	Call		
36 x 27			6432-9892p	Call			
36 x 30			6432-9902p	Call			
Reducer Gasket x Spigot							
 4" & smaller outlets are IPS 30" & 36" are CIOD		80 PSI		100 PSI		125 PSI	
	6 x 4			2932-53223	\$56.50	3032-53223	\$81.72
	8 x 4			2932-58223	\$89.60	3032-58223	\$116.36
	8 x 6			2932-58523	\$80.52	3032-58523	\$106.09
	10 x 6			2932-62623	\$129.74	3032-62623	\$179.20
	10 x 8	2832-62823	\$110.03	2932-62823	\$116.12	3032-62823	\$162.71
	12 x 8			2932-66823	\$190.19	3032-66823	\$232.60
	12 x 10	2832-67023	\$154.11	2932-67023	\$170.35	3032-67023	\$211.46
	15 x 10			2932-73023	\$316.70	3032-73023	\$356.84
	15 x 12	2832-73223	\$243.71	2932-73223	\$283.37	3032-73223	\$319.69
	18.7 x 12			2932-37723	\$601.75	3032-37723	\$624.09
	18.7 x 15	2832-37923	\$466.03	2932-37923	\$538.79	3032-37923	\$558.86
	21 x 15			2932-85523	\$936.38	3032-85523	\$1,009.85
	21 x 18.7	2832-85923	\$689.32	2932-85923	\$838.41	3032-85923	\$918.10
	24 x 18.7			2932-91923	\$1,404.09	3032-91923	\$1,693.68
	24 x 21	2832-92123	\$1,013.07	2932-92123	\$1,276.37	3032-92123	\$1,539.69
	27 x 24	2832-94823	\$1,418.66	2932-94823	\$1,783.40	3032-94823	\$2,127.57
	30 x 24			6432-97023p	Call		
	30 x 27			6432-97123p	Call		
	36 x 24			6432-98823p	Call		
36 x 27			6432-98923p	Call			
36 x 30			6432-99023p	Call			
Reducer Spigot x Gasket							
 4" & smaller outlets are IPS		80 PSI		100 PSI		125 PSI	
	6 x 4			2932-53232	\$60.32	3032-53232	\$71.08
	8 x 4			2932-58232	\$107.40	3032-58232	\$109.55
	8 x 6			2932-58532	\$75.86	3032-58532	\$82.07
	10 x 6			2932-62632	\$167.13	3032-62632	\$185.05
	10 x 8	2832-62832	\$101.79	2932-62832	\$119.94	3032-62832	\$146.82
	12 x 8			2932-66832	\$237.14	3032-66832	\$261.74
	12 x 10	2832-67032	\$146.82	2932-67032	\$160.20	3032-67032	\$207.63

Non-stocked fittings are non-returnable

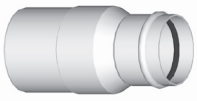

PIP 80, 100 & 125 Gasketed





Item:	Size:	Part Number:	List Price:	Part Number:	List Price:	Part Number:	List Price:
Reducer Spigot x Gasket - Continued							
 30" & 36" are CIOD	15 x 10			2932-73032	\$342.38	3032-73032	\$410.12
	15 x 12	2832-73232	\$216.35	2932-73232	\$247.77	3032-73232	\$351.47
	18.7 x 12			2932-37732	\$546.08	3032-37732	\$653.36
	18.7 x 15	2832-37932	\$423.86	2932-37932	\$479.18	3032-37932	\$558.86
	21 x 15			2932-85532	\$851.08	3032-85532	\$1,063.84
	21 x 18.7	2832-85932	\$651.21	2932-85932	\$722.29	3032-85932	\$838.41
	24 x 18.7			2932-91932	\$1,320.70	3032-91932	\$1,468.84
	24 x 21	2832-92132	\$996.95	2932-92132	\$1,200.64	3032-92132	\$1,335.28
	27 x 24	2832-94832	\$1,393.34	2932-94832	\$1,668.71	3032-94832	\$2,083.97
	30 x 24			6432-97032p	Call		
	30 x 27			6432-97132p	Call		
	36 x 24			6432-98832p	Call		
	36 x 27			6432-98932p	Call		
36 x 30			6432-99032p	Call			
11 1/4° Elbow Gasket x Gasket							
 30" & 36" are CIOD		80 PSI		100 PSI		125 PSI	
	6			2910-0602	\$75.86	3010-0602	\$89.24
	8			2910-0802	\$112.29	3010-0802	\$133.44
	10	2810-1002	\$151.00	2910-1002	\$166.41	3010-1002	\$195.80
	12	2810-1202	\$205.12	2910-1202	\$240.00	3010-1202	\$283.37
	15	2810-1502	\$361.50	2910-1502	\$396.39	3010-1502	\$469.15
	18.7	2810-1872	\$572.84	2910-1872	\$656.47	3010-1872	\$780.35
	21	2810-2102	\$846.06	2910-2102	\$910.34	3010-2102	\$1,183.67
	24	2810-2402	\$1,400.38	2910-2402	\$1,591.41	3010-2402	\$1,989.23
	27	2810-2702	\$1,811.59	2910-2702	\$2,049.21	3010-2702	\$2,487.41
	30			6410-3002	Call		
	36			6410-3602	Call		
	15° Elbow Gasket x Gasket						
 30" & 36" are CIOD		80 PSI		100 PSI		125 PSI	
	6			2911-0602	\$75.86	3011-0602	\$89.24
	8			2911-0802	\$112.29	3011-0802	\$133.44
	10	2811-1002	\$151.00	2911-1002	\$166.41	3011-1002	\$195.80
	12	2811-1202	\$205.12	2911-1202	\$240.00	3011-1202	\$283.37
	15	2811-1502	\$361.50	2911-1502	\$396.39	3011-1502	\$469.15
	18.7	2811-1872	\$572.84	2911-1872	\$656.47	3011-1872	\$780.35
	21	2811-2102	\$846.06	2911-2102	\$910.34	3011-2102	\$1,183.67
	24	2811-2402	\$1,400.38	2911-2402	\$1,591.41	3011-2402	\$1,989.23
	27	2811-2702	\$1,811.59	2911-2702	\$2,049.21	3011-2702	\$2,487.41
	30			6411-3002	Call		
	36			6411-3602	Call		
	22 1/2° Elbow Gasket x Gasket						
 30" & 36" are CIOD		80 PSI		100 PSI		125 PSI	
	6			2912-0602	\$75.86	3012-0602	\$89.24
	8			2912-0802	\$112.29	3012-0802	\$133.44
	10	2812-1002	\$151.00	2912-1002	\$166.41	3012-1002	\$195.80
	12	2812-1202	\$205.12	2912-1202	\$240.00	3012-1202	\$283.37
	15	2812-1502	\$361.50	2912-1502	\$396.39	3012-1502	\$469.15
	18.7	2812-1872	\$572.84	2912-1872	\$656.47	3012-1872	\$780.35
	21	2812-2102	\$846.06	2912-2102	\$910.34	3012-2102	\$1,183.67
	24	2812-2402	\$1,400.38	2912-2402	\$1,591.41	3012-2402	\$1,989.23
	27	2812-2702	\$1,811.59	2912-2702	\$2,049.21	3012-2702	\$2,487.41
	30			6412-3002	Call		
	36			6412-3602	Call		

Other degree elbows available, call for pricing.

Non-stocked fittings are non-returnable



PIP 80, 100 & 125 Gasketed

Item:	Size:	Part Number:	List Price:	Part Number:	List Price:	Part Number:	List Price:
30° Elbow Gasket x Gasket							
 30" & 36" are CIOD		80 PSI		100 PSI		125 PSI	
	6			2913-0602	\$89.00	3013-0602	\$108.11
	8			2913-0802	\$125.96	3013-0802	\$152.32
	10	2813-1002	\$163.31	2913-1002	\$181.10	3013-1002	\$215.51
	12	2813-1202	\$219.81	2913-1202	\$257.80	3013-1202	\$307.87
	15	2813-1502	\$447.40	2913-1502	\$521.71	3013-1502	\$582.87
	18.7	2813-1872	\$628.51	2913-1872	\$739.26	3013-1872	\$924.31
	21	2813-2102	\$936.61	2913-2102	\$1,113.91	3013-2102	\$1,316.04
	24	2813-2402	\$1,503.01	2913-2402	\$1,708.25	3013-2402	\$2,134.51
	27	2813-2702	\$2,030.34	2913-2702	\$2,309.76	3013-2702	\$2,774.73
	30			6413-3002	Call		
	36			6413-3602	Call		
45° Elbow Gasket x Gasket							
 30" & 36" are CIOD		80 PSI		100 PSI		125 PSI	
	6			2914-0602	\$89.00	3014-0602	\$108.11
	8			2914-0802	\$125.96	3014-0802	\$152.32
	10	2814-1002	\$163.31	2914-1002	\$181.10	3014-1002	\$215.51
	12	2814-1202	\$219.81	2914-1202	\$257.80	3014-1202	\$307.87
	15	2814-1502	\$447.40	2914-1502	\$521.71	3014-1502	\$582.87
	18.7	2814-1872	\$628.51	2914-1872	\$739.26	3014-1872	\$924.31
	21	2814-2102	\$936.61	2914-2102	\$1,113.91	3014-2102	\$1,316.04
	24	2814-2402	\$1,503.01	2914-2402	\$1,708.25	3014-2402	\$2,134.51
	27	2814-2702	\$2,030.34	2914-2702	\$2,309.76	3014-2702	\$2,774.73
	30			6414-3002	Call		
	36			6414-3602	Call		
60° Elbow Gasket x Gasket							
 30" & 36" are CIOD		80 PSI		100 PSI		125 PSI	
	6			2915-0602	\$100.59	3015-0602	\$126.99
	8			2915-0802	\$161.03	3015-0802	\$195.80
	10	2815-1002	\$219.09	2915-1002	\$248.48	3015-1002	\$303.08
	12	2815-1202	\$298.07	2915-1202	\$353.02	3015-1202	\$434.97
	15	2815-1502	\$571.29	2915-1502	\$721.46	3015-1502	\$813.57
	18.7	2815-1872	\$958.36	2915-1872	\$1,109.25	3015-1872	\$1,127.88
	21	2815-2102	\$1,388.80	2915-2102	\$1,665.13	3015-2102	\$2,011.09
	24	2815-2402	\$2,216.58	2915-2402	\$2,518.95	3015-2402	\$3,149.62
	27	2815-2702	\$3,007.57	2915-2702	\$3,483.52	3015-2702	\$4,141.07
	30			6415-3002	Call		
	36			6415-3602	Call		
90° Elbow Gasket x Gasket							
 30" & 36" are CIOD		80 PSI		100 PSI		125 PSI	
	6			2916-0602	\$100.59	3016-0602	\$126.99
	8			2916-0802	\$161.03	3016-0802	\$195.80
	10	2816-1002	\$219.09	2916-1002	\$248.48	3016-1002	\$303.08
	12	2816-1202	\$298.07	2916-1202	\$353.02	3016-1202	\$434.97
	15	2816-1502	\$571.29	2916-1502	\$721.46	3016-1502	\$813.57
	18.7	2816-1872	\$958.36	2916-1872	\$1,109.25	3016-1872	\$1,127.88
	21	2816-2102	\$1,388.80	2916-2102	\$1,665.13	3016-2102	\$2,011.09
	24	2816-2402	\$2,216.58	2916-2402	\$2,518.95	3016-2402	\$3,149.62
	27	2816-2702	\$3,007.57	2916-2702	\$3,483.52	3016-2702	\$4,141.07
	30			6416-3002	Call		
	36			6416-3602	Call		

Other degree elbows available, call for pricing.

Non-stocked fittings are non-returnable



PIP 80, 100 & 125 Gasketed

Item:	Size:	Part Number:	List Price:	Part Number:	List Price:	Part Number:	List Price:
Repair Tee Gasket x Gasket x FIPT							
		80 PSI		100 PSI		125 PSI	
	6 x 3			2902-530225	\$101.79	3002-530225	\$137.41
	8 x 3			2902-580225	\$138.94	3002-580225	\$187.57
	10 x 3			2902-623225	\$179.20	3002-623225	\$241.92
	12 x 3			2902-663225	\$273.10	3002-663225	\$368.68
Repair Tee Gasket x Spigot x FIPT							
		80 PSI		100 PSI		125 PSI	
	6 x 3			2902-530235	\$93.78	3002-530235	\$126.60
	8 x 3			2902-580235	\$118.99	3002-580235	\$160.63
	10 x 3			2902-623235	\$160.56	3002-623235	\$216.76
	12 x 3			2902-663235	\$230.45	3002-663235	\$311.11
Tee Gasket x Gasket x Soc							
 4" & smaller outlets are IPS		80 PSI		100 PSI		125 PSI	
	6 x 2			2901-528221	\$82.07	3001-528221	\$108.11
	6 x 3			2901-530221	\$89.96	3001-530221	\$114.44
	6 x 4			2901-532221	\$93.90	3001-532221	\$118.38
	6 x 6			2901-060221	\$101.79	3001-060221	\$164.26
	8 x 2			2901-578221	\$114.44	3001-578221	\$168.20
	8 x 3			2901-580221	\$122.33	3001-580221	\$172.14
	8 x 4	2801-582221	\$121.86	2901-582221	\$138.94	3001-582221	\$183.14
	8 x 6	2801-585221	\$130.21	2901-585221	\$146.82	3001-585221	\$191.03
	8 x 8	2801-080221	\$146.82	2901-080221	\$163.43	3001-080221	\$233.68
	10 x 2	2801-621221	\$163.43	2901-621221	\$187.91	3001-621221	\$241.56
	10 x 3	2801-623221	\$179.20	2901-623221	\$195.80	3001-623221	\$256.61
	10 x 4	2801-624221	\$187.91	2901-624221	\$203.68	3001-624221	\$266.04
	10 x 6	2801-626221	\$195.80	2901-626221	\$220.29	3001-626221	\$278.71
	10 x 8	2801-628221	\$203.68	2901-628221	\$224.24	3001-628221	\$289.70
	10 x 10	2801-100221	\$212.41	2901-100221	\$244.66	3001-100221	\$340.23
	12 x 2	2801-661221	\$224.24	2901-661221	\$228.18	3001-661221	\$314.91
	12 x 3	2801-663221	\$232.12	2901-663221	\$236.06	3001-663221	\$320.52
	12 x 4	2801-664221	\$236.06	2901-664221	\$244.66	3001-664221	\$333.07
	12 x 6	2801-666221	\$244.66	2901-666221	\$265.22	3001-666221	\$372.61
	12 x 8	2801-668221	\$252.67	2901-668221	\$284.93	3001-668221	\$391.61
	12 x 10	2801-670221	\$260.56	2901-670221	\$305.47	3001-670221	\$415.26
	12 x 12	2801-120221	\$284.93	2901-120221	\$326.02	3001-120221	\$493.39
	15 x 2	2801-721221	\$275.49	2901-721221	\$346.57	3001-721221	\$515.49
	15 x 3	2801-723221	\$280.27	2901-723221	\$366.28	3001-723221	\$536.76
	15 x 4	2801-724221	\$284.93	2901-724221	\$386.83	3001-724221	\$559.70
	15 x 6	2801-726221	\$305.47	2901-726221	\$407.38	3001-726221	\$579.41
	15 x 8	2801-728221	\$326.02	2901-728221	\$427.81	3001-728221	\$606.29
	15 x 10	2801-730221	\$366.28	2901-730221	\$425.53	3001-730221	\$642.61
	15 x 12	2801-732221	\$386.83	2901-732221	\$509.16	3001-732221	\$681.20
	15 x 15	2801-150221	\$468.07	2901-150221	\$569.97	3001-150221	\$878.55
	18.7 x 2	2801-370221	\$407.38	2901-370221	\$468.07	3001-370221	\$784.65
	18.7 x 3	2801-371221	\$415.26	2901-371221	\$488.61	3001-371221	\$801.26
	18.7 x 4	2801-372221	\$427.81	2901-372221	\$509.16	3001-372221	\$806.76
	18.7 x 6	2801-374221	\$448.36	2901-374221	\$610.95	3001-374221	\$832.08
18.7 x 8	2801-375221	\$468.07	2901-375221	\$692.31	3001-375221	\$987.50	
18.7 x 10	2801-376221	\$509.16	2901-376221	\$773.66	3001-376221	\$1,183.31	
18.7 x 12	2801-377221	\$566.74	2901-377221	\$854.90	3001-377221	\$1,254.40	
18.7 x 15	2801-379221	\$592.08	2901-379221	\$896.00	3001-379221	\$1,330.13	
18.7 x 18.7	2801-187221	\$711.30	2901-187221	\$936.25	3001-187221	\$1,657.71	

Non-stocked fittings are non-returnable

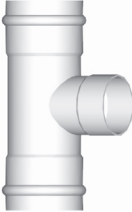

PIP 80, 100 & 125 Gasketed

Item:	Size:	Part Number:	List Price:	Part Number:	List Price:	Part Number:	List Price:
Tee Gasket x Gasket x Soc - Continued							
 30" & 36" are CIOD	80 PSI		100 PSI		125 PSI		
	21 x 2	2801-841221	\$610.95	2901-841221	\$753.11	3001-841221	\$1,292.27
	21 x 3	2801-843221	\$618.83	2901-843221	\$761.00	3001-843221	\$1,345.90
	21 x 4	2801-844221	\$630.78	2901-844221	\$773.66	3001-844221	\$1,439.80
	21 x 6	2801-846221	\$636.99	2901-846221	\$813.93	3001-846221	\$1,473.74
	21 x 8	2801-848221	\$671.04	2901-848221	\$915.71	3001-848221	\$1,531.44
	21 x 10	2801-850221	\$691.47	2901-850221	\$1,119.40	3001-850221	\$1,631.67
	21 x 12	2801-852221	\$759.45	2901-852221	\$1,221.18	3001-852221	\$1,744.57
	21 x 15	2801-855221	\$810.03	2901-855221	\$1,302.54	3001-855221	\$1,936.31
	21 x 18.7	2801-859221	\$863.49	2901-859221	\$1,383.78	3001-859221	\$2,192.09
	21 x 21	2801-210221	\$1,060.98	2901-210221	\$1,627.73	3001-210221	\$2,627.07
	24 x 6	2801-906221	\$1,627.73	2901-906221	\$2,181.82	3001-906221	\$2,727.30
	24 x 8	2801-908221	\$1,709.09	2901-908221	\$2,302.60	3001-908221	\$2,878.06
	24 x 10	2801-910221	\$1,791.16	2901-910221	\$2,417.16	3001-910221	\$3,021.78
	24 x 12	2801-912221	\$1,872.39	2901-912221	\$2,505.57	3001-912221	\$3,131.45
	24 x 15	2801-915221	\$1,953.75	2901-915221	\$2,676.05	3001-915221	\$3,344.59
	24 x 18.7	2801-919221	\$2,035.00	2901-919221	\$2,831.47	3001-919221	\$3,539.67
	24 x 21	2801-921221	\$2,238.68	2901-921221	\$2,976.03	3001-921221	\$3,720.43
	24 x 24	2801-240221	\$2,482.64	2901-240221	\$3,089.64	3001-240221	\$3,861.64
	27 x 6	2801-936221	\$2,401.28	2901-936221	\$2,727.30	3001-936221	\$3,409.35
	27 x 8	2801-938221	\$2,522.89	2901-938221	\$2,878.06	3001-938221	\$3,597.98
	27 x 10	2801-940221	\$2,645.23	2901-940221	\$3,021.78	3001-940221	\$3,776.46
	27 x 12	2801-941221	\$2,747.01	2901-941221	\$3,131.45	3001-941221	\$3,914.56
	27 x 15	2801-943221	\$2,950.71	2901-943221	\$3,344.59	3001-943221	\$4,180.61
	27 x 18.7	2801-949221	\$3,113.30	2901-949221	\$3,539.67	3001-949221	\$4,424.45
	27 x 21	2801-947221	\$3,255.46	2901-947221	\$3,720.73	3001-947221	\$4,650.24
	27 x 24	2801-948221	\$3,418.06	2901-948221	\$3,861.64	3001-948221	\$4,781.29
	27 x 27	2801-270221	\$4,069.27	2901-270221	\$4,633.75	3001-270221	\$5,697.00
	30 x 6			6401-960221p	Call		
	30 x 8			6401-961221p	Call		
	30 x 10			6401-962221p	Call		
	30 x 12			6401-963221p	Call		
	30 x 15			6401-965221p	Call		
	30 x 18.7			6401-922221p	Call		
	30 x 21			6401-969221p	Call		
	30 x 24			6401-970221p	Call		
30 x 27			6401-971221p	Call			
30 x 30			6401-300221	Call			
36 x 6			6401-978221p	Call			
36 x 8			6401-979221p	Call			
36 x 10			6401-980221p	Call			
36 x 12			6401-981221p	Call			
36 x 15			6401-983221p	Call			
36 x 18.7			6401-923221p	Call			
36 x 21			6401-987221p	Call			
36 x 24			6401-988221p	Call			
36 x 27			6401-989221p	Call			
36 x 30			6401-990221	Call			
36 x 36			6401-360221	Call			

Non-stocked fittings are non-returnable



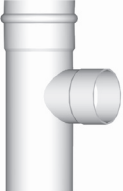

PIP 80, 100 & 125 Gasketed

Item:	Size:	Part Number:	List Price:	Part Number:	List Price:	Part Number:	List Price:
Tee Gasket x Spigot x Soc							
 4" & smaller outlets are IPS		80 PSI		100 PSI		125 PSI	
	6 x 2			2901-528231	\$82.07	3001-528231	\$108.11
	6 x 3			2901-530231	\$89.96	3001-530231	\$114.44
	6 x 4			2901-532231	\$93.90	3001-532231	\$118.38
	6 x 6			2901-060231	\$101.79	3001-060231	\$164.26
	8 x 2			2901-578231	\$114.44	3001-578231	\$168.20
	8 x 3			2901-580231	\$122.33	3001-580231	\$172.14
	8 x 4	2801-582231	\$121.86	2901-582231	\$138.94	3001-582231	\$183.14
	8 x 6	2801-585231	\$130.21	2901-585231	\$146.82	3001-585231	\$191.03
	8 x 8	2801-080231	\$146.82	2901-080231	\$163.43	3001-080231	\$233.68
	10 x 2	2801-621231	\$163.43	2901-621231	\$187.91	3001-621231	\$241.56
	10 x 3	2801-623231	\$179.20	2901-623231	\$195.80	3001-623231	\$256.61
	10 x 4	2801-624231	\$187.91	2901-624231	\$203.68	3001-624231	\$266.04
	10 x 6	2801-626231	\$195.80	2901-626231	\$220.29	3001-626231	\$278.71
	10 x 8	2801-628231	\$203.68	2901-628231	\$224.24	3001-628231	\$289.70
	10 x 10	2801-100231	\$212.41	2901-100231	\$244.66	3001-100231	\$340.23
	12 x 2	2801-661231	\$224.24	2901-661231	\$228.18	3001-661231	\$314.91
	12 x 3	2801-663231	\$232.12	2901-663231	\$236.06	3001-663231	\$320.52
	12 x 4	2801-664231	\$236.06	2901-664231	\$244.66	3001-664231	\$333.07
	12 x 6	2801-666231	\$244.66	2901-666231	\$265.22	3001-666231	\$372.61
	12 x 8	2801-668231	\$252.67	2901-668231	\$284.93	3001-668231	\$391.61
	12 x 10	2801-670231	\$260.56	2901-670231	\$305.47	3001-670231	\$415.26
	12 x 12	2801-120231	\$284.93	2901-120231	\$326.02	3001-120231	\$493.39
	15 x 2	2801-721231	\$275.49	2901-721231	\$346.57	3001-721231	\$515.49
	15 x 3	2801-723231	\$280.27	2901-723231	\$366.28	3001-723231	\$536.76
	15 x 4	2801-724231	\$284.93	2901-724231	\$386.83	3001-724231	\$559.70
	15 x 6	2801-726231	\$305.47	2901-726231	\$407.38	3001-726231	\$579.41
	15 x 8	2801-728231	\$326.02	2901-728231	\$427.81	3001-728231	\$606.29
	15 x 10	2801-730231	\$366.28	2901-730231	\$425.53	3001-730231	\$642.61
	15 x 12	2801-732231	\$386.83	2901-732231	\$509.16	3001-732231	\$681.20
	15 x 15	2801-150231	\$468.07	2901-150231	\$569.97	3001-150231	\$878.55
	18.7 x 2	2801-370231	\$407.38	2901-370231	\$468.07	3001-370231	\$784.65
	18.7 x 3	2801-371231	\$415.26	2901-371231	\$488.61	3001-371231	\$801.26
	18.7 x 4	2801-372231	\$427.18	2901-372231	\$509.16	3001-372231	\$806.76
	18.7 x 6	2801-374231	\$448.36	2901-374231	\$610.95	3001-374231	\$832.08
18.7 x 8	2801-375231	\$468.07	2901-375231	\$692.31	3001-375231	\$987.50	
18.7 x 10	2801-376231	\$509.16	2901-376231	\$773.66	3001-376231	\$1,183.31	
18.7 x 12	2801-377231	\$566.74	2901-377231	\$854.90	3001-377231	\$1,254.40	
18.7 x 15	2801-379231	\$592.08	2901-379231	\$896.00	3001-379231	\$1,330.13	
18.7 x 18.7	2801-187231	\$711.30	2901-187231	\$936.25	3001-187231	\$1,657.71	
21 x 2	2801-841231	\$610.95	2901-841231	\$753.11	3001-841231	\$1,292.27	
21 x 3	2801-843231	\$618.83	2901-843231	\$761.00	3001-843231	\$1,345.90	
21 x 4	2801-844231	\$630.78	2901-844231	\$773.66	3001-844231	\$1,439.80	
21 x 6	2801-846231	\$636.99	2901-846231	\$813.93	3001-846231	\$1,473.74	
21 x 8	2801-848231	\$671.04	2901-848231	\$915.71	3001-848231	\$1,531.44	
21 x 10	2801-850231	\$691.47	2901-850231	\$1,119.40	3001-850231	\$1,631.67	
21 x 12	2801-852231	\$759.45	2901-852231	\$1,221.18	3001-852231	\$1,744.57	
21 x 15	2801-855231	\$980.46	2901-855231	\$1,302.54	3001-855231	\$1,936.31	
21 x 18.7	2801-859231	\$929.92	2901-859231	\$1,383.78	3001-859231	\$2,192.09	
21 x 21	2801-210231	\$1,060.98	2901-210231	\$1,627.73	3001-210231	\$2,627.07	



PIP 80, 100 & 125 Gasketed

Item:	Size:	Part Number:	List Price:	Part Number:	List Price:	Part Number:	List Price:	
Tee Gasket x Spigot x Soc								
 30" & 36" are CIOD		80 PSI		100 PSI		125 PSI		
	24 x 6	2801-906231	\$1,627.73	2901-906231	\$2,181.82	3001-906231	\$2,727.30	
	24 x 8	2801-908231	\$1,709.09	2901-908231	\$2,302.60	3001-908231	\$2,878.06	
	24 x 10	2801-910231	\$1,791.16	2901-910231	\$2,417.16	3001-910231	\$3,021.78	
	24 x 12	2801-912231	\$1,872.39	2901-912231	\$2,505.57	3001-912231	\$3,131.45	
	24 x 15	2801-915231	\$1,953.75	2901-915231	\$2,676.05	3001-915231	\$3,344.59	
	24 x 18.7	2801-919231	\$2,035.00	2901-919231	\$2,831.47	3001-919231	\$3,539.67	
	24 x 21	2801-921231	\$2,238.68	2901-921231	\$2,976.03	3001-921231	\$3,720.43	
	24 x 24	2801-240231	\$2,482.64	2901-240231	\$3,089.64	3001-240231	\$3,861.64	
	27 x 6	2801-936231	\$2,401.28	2901-936231	\$2,727.30	3001-936231	\$3,409.34	
	27 x 8	2801-938231	\$2,522.89	2901-938231	\$2,878.06	3001-938231	\$3,597.98	
	27 x 10	2801-940231	\$2,645.23	2901-940231	\$3,021.78	3001-940231	\$3,776.46	
	27 x 12	2801-941231	\$2,747.01	2901-941231	\$3,131.45	3001-941231	\$3,914.56	
	27 x 15	2801-943231	\$2,950.71	2901-943231	\$3,344.59	3001-943231	\$4,180.61	
	27 x 18.7	2801-949231	\$3,113.30	2901-949231	\$3,539.67	3001-949231	\$4,424.45	
	27 x 21	2801-947231	\$3,255.46	2901-947231	\$3,720.43	3001-947231	\$4,650.24	
	27 x 24	2801-948231	\$3,418.06	2901-948231	\$3,861.64	3001-948231	\$4,781.29	
	27 x 27	2801-270231	\$4,069.27	2901-270231	\$4,633.75	3001-270231	\$5,697.00	
	30 x 6				6401-960231p	Call		
	30 x 8				6401-961231p	Call		
	30 x 10				6401-962231p	Call		
	30 x 12				6401-963231p	Call		
	30 x 15				6401-965231p	Call		
	30 x 18.7				6401-922231p	Call		
	30 x 21				6401-969231p	Call		
	30 x 24				6401-970231p	Call		
	30 x 27				6401-971231p	Call		
	30 x 30				6401-300231	Call		
	36 x 6				6401-978231p	Call		
	36 x 8				6401-979231p	Call		
	36 x 10				6401-980231p	Call		
	36 x 12				6401-981231p	Call		
	36 x 15				6401-983231p	Call		
	36 x 18.7				6401-923231p	Call		
	36 x 21				6401-987231p	Call		
	36 x 24				6401-988231p	Call		
36 x 27				6401-989231p	Call			
36 x 30				6401-990231	Call			
36 x 36				6401-360231	Call			
Tee Gasket x Gasket x Gasket								
 4" & smaller outlets are IPS		80 PSI		100 PSI		125 PSI		
	6 x 4			2901-5322	\$112.29	3001-5322	\$121.86	
	6 x 6			2901-0602	\$119.94	3001-0602	\$130.21	
	8 x 4			2901-5822	\$136.19	3001-5822	\$146.82	
	8 x 6			2901-5852	\$143.95	3001-5852	\$171.32	
	8 x 8			2901-0802	\$160.20	3001-0802	\$195.80	
	10 x 4	2801-6242	\$191.97	2901-6242	\$199.74	3001-6242	\$212.41	
	10 x 6	2801-6262	\$195.56	2901-6262	\$208.23	3001-6262	\$236.06	
	10 x 8	2801-6282	\$215.63	2901-6282	\$223.75	3001-6282	\$256.61	
	10 x 10	2801-1002	\$219.58	2901-1002	\$243.82	3001-1002	\$293.64	
	12 x 4	2801-6642	\$223.40	2901-6642	\$251.60	3001-6642	\$284.93	
	12 x 6	2801-6662	\$229.61	2901-6662	\$260.08	3001-6662	\$305.47	
	12 x 8	2801-6682	\$265.93	2901-6682	\$290.24	3001-6682	\$326.02	
	12 x 10	2801-6702	\$273.57	2901-6702	\$295.68	3001-6702	\$366.28	
	12 x 12	2801-1202	\$302.96	2901-1202	\$331.27	3001-1202	\$407.38	

Non-stocked fittings are non-returnable



PIP 80, 100 & 125 Gasketed

Item:	Size:	Part Number:	List Price:	Part Number:	List Price:	Part Number:	List Price:
Tee Gasket x Gasket x Gasket - Continued							
 <p>4" & smaller outlets are IPS 30" & 36" are CIOD</p>	80 PSI		100 PSI		125 PSI		
	15 x 4	2801-7242	\$358.64	2901-7242	\$379.30	3001-7242	\$499.25
	15 x 6	2801-7262	\$363.29	2901-7262	\$439.76	3001-7262	\$531.03
	15 x 8	2801-7282	\$382.65	2901-7282	\$447.40	3001-7282	\$551.22
	15 x 10	2801-7302	\$411.91	2901-7302	\$459.11	3001-7302	\$579.05
	15 x 12	2801-7322	\$439.04	2901-7322	\$499.25	3001-7322	\$618.48
	15 x 15	2801-1502	\$483.84	2901-1502	\$599.12	3001-1502	\$718.35
	18.7 x 4	2801-3722	\$465.32	2901-3722	\$519.43	3001-3722	\$638.67
	18.7 x 6	2801-3742	\$498.53	2901-3742	\$525.26	3001-3742	\$698.99
	18.7 x 8	2801-3752	\$509.40	2901-3752	\$630.90	3001-3752	\$758.61
	18.7 x 10	2801-3762	\$566.51	2901-3762	\$658.74	3001-3762	\$818.23
	18.7 x 12	2801-3772	\$614.53	2901-3772	\$698.99	3001-3772	\$858.48
	18.7 x 15	2801-3792	\$642.36	2901-3792	\$738.54	3001-3792	\$918.10
	18.7 x 18.7	2801-1872	\$771.39	2901-1872	\$897.90	3001-1872	\$1,157.27
	21 x 4	2801-8442	\$721.93	2901-8442	\$878.55	3001-8442	\$1,057.39
	21 x 6	2801-8462	\$729.70	2901-8462	\$897.90	3001-8462	\$1,077.59
	21 x 8	2801-8482	\$768.29	2901-8482	\$945.93	3001-8482	\$1,129.43
	21 x 10	2801-8502	\$792.30	2901-8502	\$958.36	3001-8502	\$1,165.75
	21 x 12	2801-8522	\$869.59	2901-8522	\$1,017.97	3001-8522	\$1,277.34
	21 x 15	2801-8552	\$941.52	2901-8552	\$1,057.39	3001-8552	\$1,377.08
	21 x 18.7	2801-8592	\$1,065.16	2901-8592	\$1,277.34	3001-8592	\$1,556.77
	21 x 21	2801-2102	\$1,214.26	2901-2102	\$1,496.32	3001-2102	\$1,827.72
	24 x 6	2801-9062	\$1,939.54	2901-9062	\$2,197.71	3001-9062	\$2,747.01
	24 x 8	2801-9082	\$2,041.32	2901-9082	\$2,278.94	3001-9082	\$2,889.17
	24 x 10	2801-9102	\$2,145.49	2901-9102	\$2,320.04	3001-9102	\$3,051.78
	24 x 12	2801-9122	\$2,261.62	2901-9122	\$2,380.85	3001-9122	\$3,215.21
	24 x 15	2801-9152	\$2,380.01	2901-9152	\$2,482.64	3001-9152	\$3,377.80
	24 x 18.7	2801-9192	\$2,503.18	2901-9192	\$2,604.13	3001-9192	\$3,540.39
	24 x 21	2801-9212	\$2,635.79	2901-9212	\$2,767.56	3001-9212	\$3,744.08
	24 x 24	2801-2402	\$2,773.89	2901-2402	\$2,889.17	3001-2402	\$3,939.05
	27 x 6	2801-9362	\$2,424.22	2901-9362	\$2,747.01	3001-9362	\$3,459.03
	27 x 8	2801-9382	\$2,551.33	2901-9382	\$2,889.17	3001-9382	\$3,621.74
	27 x 10	2801-9402	\$2,682.38	2901-9402	\$3,051.78	3001-9402	\$3,784.35
	27 x 12	2801-9412	\$2,827.53	2901-9412	\$3,215.21	3001-9412	\$3,967.49
	27 x 15	2801-9432	\$2,976.03	2901-9432	\$3,377.80	3001-9432	\$4,110.37
27 x 18.7	2801-9492	\$3,129.91	2901-9492	\$3,560.94	3001-9492	\$4,435.56	
27 x 21	2801-9472	\$3,294.88	2901-9472	\$3,744.08	3001-9472	\$4,679.51	
27 x 24	2801-9482	\$3,468.60	2901-9482	\$3,906.67	3001-9482	\$4,943.88	
27 x 27	2801-2702	\$3,987.92	2901-2702	\$4,577.60	3001-2702	\$5,798.79	
30 x 6			6401-9602p	Call			
30 x 8			6401-9612p	Call			
30 x 10			6401-9622p	Call			
30 x 12			6401-9632p	Call			
30 x 15			6401-9652p	Call			
30 x 18.7			6401-9222p	Call			
30 x 21			6401-9692p	Call			
30 x 24			6401-9702p	Call			
30 x 27			6401-9712p	Call			
30 x 30			6401-3002	Call			





PIP 80#, 100# & 125# Gasketed

Item:	Size:	Part Number:	List Price:	Part Number:	List Price:	Part Number:	List Price:
Tee Gasket x Gasket x Gasket - Continued							
 30" & 36" are CIOD		80 PSI		100 PSI		125 PSI	
	36 x 6			6401-9782p	Call		
	36 x 8			6401-9792p	Call		
	36 x 10			6401-9802p	Call		
	36 x 12			6401-9812p	Call		
	36 x 15			6401-9832p	Call		
	36 x 18.7			6401-9232p	Call		
	36 x 21			6401-9872p	Call		
	36 x 24			6401-9882p	Call		
	36 x 27			6401-9892p	Call		
	36 x 30			6401-9902	Call		
	36 x 36			6401-3602	Call		

Tee Gasket x Spigot x Gasket							
 4" & smaller outlets are IPS		80 PSI		100 PSI		125 PSI	
	6 x 4			2901-532232	\$112.29	3001-532232	\$121.86
	6 x 6			2901-060232	\$119.94	3001-060232	\$130.21
	8 x 4			2901-582232	\$136.19	3001-582232	\$146.82
	8 x 6			2901-585232	\$143.95	3001-585232	\$171.32
	8 x 8			2901-080232	\$160.20	3001-080232	\$195.80
	10 x 4	2801-624232	\$191.97	2901-624232	\$199.74	3001-624232	\$212.41
	10 x 6	2801-626232	\$195.56	2901-626232	\$208.23	3001-626232	\$236.06
	10 x 8	2801-628232	\$215.63	2901-628232	\$223.75	3001-628232	\$256.61
	10 x 10	2801-100232	\$219.58	2901-100232	\$243.82	3001-100232	\$293.64
	12 x 4	2801-664232	\$223.40	2901-664232	\$251.60	3001-664232	\$284.93
	12 x 6	2801-666232	\$229.61	2901-666232	\$260.08	3001-666232	\$305.47
	12 x 8	2801-668232	\$265.93	2901-668232	\$290.24	3001-668232	\$326.02
	12 x 10	2801-670232	\$273.57	2901-670232	\$295.68	3001-670232	\$366.28
	12 x 12	2801-120232	\$302.96	2901-120232	\$331.27	3001-120232	\$407.38
	15 x 4	2801-724232	\$358.64	2901-724232	\$379.30	3001-724232	\$499.25
	15 x 6	2801-726232	\$363.29	2901-726232	\$439.76	3001-726232	\$531.03
	15 x 8	2801-728232	\$382.65	2901-728232	\$447.40	3001-728232	\$551.22
	15 x 10	2801-730232	\$411.91	2901-730232	\$459.11	3001-730232	\$579.05
	15 x 12	2801-732232	\$439.04	2901-732232	\$499.25	3001-732232	\$618.48
	15 x 15	2801-150232	\$483.84	2901-150232	\$599.12	3001-150232	\$718.35
	18.7 x 4	2801-372232	\$465.32	2901-372232	\$519.43	3001-372232	\$638.67
	18.7 x 6	2801-374232	\$498.53	2901-374232	\$525.26	3001-374232	\$698.99
	18.7 x 8	2801-375232	\$509.40	2901-375232	\$630.90	3001-375232	\$758.61
	18.7 x 10	2801-376232	\$566.51	2901-376232	\$658.74	3001-376232	\$818.23
	18.7 x 12	2801-377232	\$614.53	2901-377232	\$698.99	3001-377232	\$858.48
	18.7 x 15	2801-379232	\$642.36	2901-379232	\$738.54	3001-379232	\$918.10
	18.7 x 18.7	2801-187232	\$771.39	2901-187232	\$897.90	3001-187232	\$1,157.27
	21 x 4	2801-844232	\$721.93	2901-844232	\$878.55	3001-844232	\$1,057.39
	21 x 6	2801-846232	\$729.70	2901-846232	\$897.90	3001-846232	\$1,077.59
	21 x 8	2801-848232	\$768.29	2901-848232	\$945.93	3001-848232	\$1,129.43
	21 x 10	2801-850232	\$792.30	2901-850232	\$958.36	3001-850232	\$1,165.75
21 x 12	2801-852232	\$869.59	2901-852232	\$1,017.97	3001-852232	\$1,277.34	
21 x 15	2801-855232	\$941.52	2901-855232	\$1,057.39	3001-855232	\$1,377.08	
21 x 18.7	2801-859232	\$1,065.16	2901-859232	\$1,277.34	3001-859232	\$1,556.77	
21 x 21	2801-210232	\$1,214.26	2901-210232	\$1,496.32	3001-210232	\$1,827.72	



PIP 80, 100 & 125 Gasketed

Item:	Size:	Part Number:	List Price:	Part Number:	List Price:	Part Number:	List Price:	
Tee Gasket x Spigot x Gasket - Continued								
 30" & 36" are CIOD		80 PSI		100 PSI		125 PSI		
	24 x 6	2801-906232	\$1,939.54	2901-906232	\$2,197.71	3001-906232	\$2,747.01	
	24 x 8	2801-908232	\$2,041.32	2901-908232	\$2,278.94	3001-908232	\$2,889.17	
	24 x 10	2801-910232	\$2,145.49	2901-910232	\$2,320.04	3001-910232	\$3,051.78	
	24 x 12	2801-912232	\$2,261.62	2901-912232	\$2,380.85	3001-912232	\$3,215.21	
	24 x 15	2801-915232	\$2,380.01	2901-915232	\$2,482.64	3001-915232	\$3,377.80	
	24 x 18.7	2801-919232	\$2,503.18	2901-919232	\$2,604.13	3001-919232	\$3,540.39	
	24 x 21	2801-921232	\$2,635.79	2901-921232	\$2,767.56	3001-921232	\$3,744.08	
	24 x 24	2801-240232	\$2,773.89	2901-240232	\$2,889.17	3001-240232	\$3,939.05	
	27 x 6	2801-936232	\$2,424.22	2901-936232	\$2,747.01	3001-936232	\$3,459.03	
	27 x 8	2801-938232	\$2,551.33	2901-938232	\$2,889.17	3001-938232	\$3,621.74	
	27 x 10	2801-940232	\$2,682.38	2901-940232	\$3,051.78	3001-940232	\$3,784.35	
	27 x 12	2801-941232	\$2,827.53	2901-941232	\$3,215.21	3001-941232	\$3,967.49	
	27 x 15	2801-943232	\$2,976.03	2901-943232	\$3,377.80	3001-943232	\$4,110.37	
	27 x 18.7	2801-949232	\$3,129.91	2901-949232	\$3,560.94	3001-949232	\$4,435.56	
	27 x 21	2801-947232	\$3,294.88	2901-947232	\$3,744.08	3001-947232	\$4,679.51	
	27 x 24	2801-948232	\$3,468.60	2901-948232	\$3,906.67	3001-948232	\$4,943.88	
	27 x 27	2801-270232	\$3,987.92	2901-270232	\$4,577.60	3001-270232	\$5,798.79	
	30 x 6				6401-960232p	Call		
	30 x 8				6401-961232p	Call		
	30 x 10				6401-962232p	Call		
	30 x 12				6401-963232p	Call		
	30 x 15				6401-965232p	Call		
	30 x 18.7				6401-922232p	Call		
	30 x 21				6401-969232p	Call		
	30 x 24				6401-970232p	Call		
	30 x 27				6401-971232p	Call		
	30 x 30				6401-300232	Call		
	36 x 6				6401-978232p	Call		
	36 x 8				6401-979232p	Call		
	36 x 10				6401-980232p	Call		
	36 x 12				6401-981232p	Call		
	36 x 15				6401-983232p	Call		
	36 x 18.7				6401-923232p	Call		
	36 x 21				6401-987232p	Call		
	36 x 24				6401-988232p	Call		
36 x 27				6401-989232p	Call			
36 x 30				6401-990232	Call			
36 x 36				6401-360232	Call			
Riser Tee Gasket x Spigot x FIPT								
 "M" indicates a molded fitting * 4" bodies are IPS size		80 PSI		100 PSI		125 PSI		
	*4 x 2					3301-420235	\$57.34	
	*4 x 3					3301-422235	\$76.70	
	*4 x 4					3301-040235	\$89.60	
	6 x 2				2901-528235	\$68.10	3001-528235	\$82.07
	6 x 3				2901-530235M	\$90.64	3001-530235M	\$90.64
	6 x 4				2901-532235	\$92.11	3001-532235	\$106.56
	8 x 2				2901-578235	\$95.93	3001-578235	\$122.33
	8 x 3				2901-580235M	\$121.55	3001-580235M	\$121.55
	8 x 4				2901-582235	\$123.88	3001-582235	\$138.94
	10 x 2	2801-621235	\$131.05	2901-621235	\$143.95	3001-621235	\$163.43	
	10 x 3	2801-623235	\$138.10	2901-623235	\$151.72	3001-623235	\$175.26	
10 x 4	2801-624235	\$141.32	2901-624235	\$157.93	3001-624235	\$191.86		



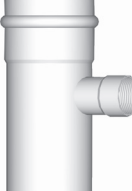

PIP 80, 100 & 125 Gasketed

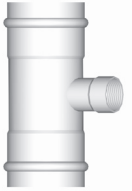
Item:	Size:	Part Number:	List Price:	Part Number:	List Price:	Part Number:	List Price:
Riser Tee Gasket x Spigot x FIPT - Continued							
 30" & 36" are CIOD		80 PSI		100 PSI		125 PSI	
	12 x 2	2801-661235	\$192.57	2901-661235	\$199.74	3001-661235	\$224.24
	12 x 3	2801-663235	\$199.74	2901-663235	\$215.99	3001-663235	\$244.66
	12 x 4	2801-664235	\$202.14	2901-664235	\$223.75	3001-664235	\$265.22
	15 x 2	2801-721235	\$256.61	2901-721235	\$279.43	3001-721235	\$340.36
	15 x 3	2801-723235	\$270.83	2901-723235	\$295.68	3001-723235	\$364.73
	15 x 4	2801-724235	\$293.64	2901-724235	\$319.69	3001-724235	\$397.70
	18.7 x 2	2801-370235	\$535.20	2901-370235	\$594.46	3001-370235	\$743.56
	18.7 x 3	2801-371235	\$558.86	2901-371235	\$614.17	3001-371235	\$768.05
	18.7 x 4	2801-372235	\$571.52	2901-372235	\$618.83	3001-372235	\$777.60
	21 x 2	2801-841235	\$851.79	2901-841235	\$896.00	3001-841235	\$1,181.76
	21 x 3	2801-843235	\$858.01	2901-843235	\$928.37	3001-843235	\$1,191.20
	21 x 4	2801-844235	\$881.47	2901-844235	\$936.25	3001-844235	\$1,225.12
	24 x 2	2801-901235	\$1,172.20	2901-901235	\$1,302.54	3001-901235	\$1,627.73
	24 x 3	2801-903235	\$1,200.64	2901-903235	\$1,334.08	3001-903235	\$1,667.15
	24 x 4	2801-904235	\$1,235.40	2901-904235	\$1,373.62	3001-904235	\$1,715.30
	27 x 2	2801-931235	\$1,424.88	2901-931235	\$1,627.73	3001-931235	\$2,034.28
	27 x 3	2801-933235	\$1,465.14	2901-933235	\$1,668.71	3001-933235	\$2,084.81
	27 x 4	2801-934235	\$1,506.11	2901-934235	\$1,709.09	3001-934235	\$2,145.49
	30 x 2			6401-955235p	Call		
30 x 3			6401-957235p	Call			
30 x 4			6401-959235p	Call			
36 x 3			6401-975235p	Call			
36 x 4			6401-976235p	Call			

Riser Tee Gasket x Gasket x FIPT							
 * 4" bodies are IPS size		80 PSI		100 PSI		125 PSI	
	•4 x 2					3301-420225	\$65.23
	•4 x 3					3301-422225	\$81.72
	•4 x 4					3301-040225	\$97.48
	6 x 2			2901-528225	\$72.04	3001-528225	\$86.02
	6 x 3			2901-530225	\$88.28	3001-530225	\$88.28
	6 x 4			2901-532225	\$95.93	3001-532225	\$112.90
	8 x 2			2901-578225	\$108.35	3001-578225	\$131.05
	8 x 3			2901-580225	\$118.38	3001-580225	\$118.38
	8 x 4			2901-582225	\$127.70	3001-582225	\$163.43
	10 x 2	2801-621225	\$142.88	2901-621225	\$156.37	3001-621225	\$190.19
	10 x 3	2801-623225	\$150.76	2901-623225	\$171.91	3001-623225	\$207.63
	10 x 4	2801-624225	\$163.43	2901-624225	\$184.22	3001-624225	\$220.29
	12 x 2	2801-661225	\$195.80	2901-661225	\$219.81	3001-661225	\$265.22
	12 x 3	2801-663225	\$203.68	2901-663225	\$231.40	3001-663225	\$279.43
	12 x 4	2801-664225	\$216.35	2901-664225	\$247.77	3001-664225	\$296.04
	15 x 2	2801-721225	\$293.64	2901-721225	\$319.69	3001-721225	\$390.66
	15 x 3	2801-723225	\$305.47	2901-723225	\$331.27	3001-723225	\$424.46
	15 x 4	2801-724225	\$326.02	2901-724225	\$347.52	3001-724225	\$446.44
	18.7 x 2	2801-370225	\$529.72	2901-370225	\$590.52	3001-370225	\$775.94
18.7 x 3	2801-371225	\$549.43	2901-371225	\$602.35	3001-371225	\$788.59	
18.7 x 4	2801-372225	\$558.14	2901-372225	\$618.83	3001-372225	\$796.48	
21 x 2	2801-841225	\$822.53	2901-841225	\$936.25	3001-841225	\$1,196.70	
21 x 3	2801-843225	\$834.36	2901-843225	\$948.80	3001-843225	\$1,208.52	
21 x 4	2801-844225	\$854.90	2901-844225	\$985.12	3001-844225	\$1,242.45	
24 x 2	2801-901225	\$1,147.83	2901-901225	\$1,343.52	3001-901225	\$1,675.04	
24 x 3	2801-903225	\$1,164.32	2901-903225	\$1,359.29	3001-903225	\$1,691.65	
24 x 4	2801-904225	\$1,180.09	2901-904225	\$1,375.90	3001-904225	\$1,740.63	

Non-stocked fittings are non-returnable

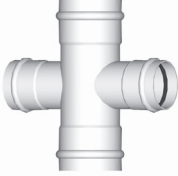
PIP 80, 100 & 125 Gasketed

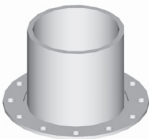
Item:	Size:	Part Number:	List Price:	Part Number:	List Price:	Part Number:	List Price:
Riser Tee Gasket x Gasket x FIPT							
 30" & 36" are CIOD		80 PSI		100 PSI		125 PSI	
	27 x 2	2801-931225	\$1,449.37	2901-931225	\$1,652.22	3001-931225	\$2,055.54
	27 x 3	2801-933225	\$1,465.14	2901-933225	\$1,668.71	3001-933225	\$2,075.25
	27 x 4	2801-934225	\$1,506.11	2901-934225	\$1,689.25	3001-934225	\$2,095.80
	30 x 2			6401-955225p	Call		
	30 x 3			6401-957225p	Call		
	30 x 4			6401-959225p	Call		
	36 x 3			6401-975225p	Call		
	36 x 4			6401-976225p	Call		
Cross Gasket x Gasket x Gasket x Gasket							
 Reducing crosses are available. Call for pricing. 30" & 36" are CIOD		80 PSI		100 PSI		125 PSI	
	6 x 6			2908-0602	\$159.49	3008-0602	\$215.31
	8 x 8			2908-0802	\$229.85	3008-0802	\$310.30
	10 x 10	2808-1002	\$322.08	2908-1002	\$334.71	3008-1002	\$451.86
	12 x 12	2808-1202	\$462.09	2908-1202	\$480.73	3008-1202	\$648.98
	15 x 15	2808-1502	\$721.46	2908-1502	\$832.20	3008-1502	\$1,123.47
	18.7 x 18.7	2808-1872	\$1,109.25	2908-1872	\$1,257.14	3008-1872	\$1,697.15
	21 x 21	2808-2102	\$1,836.20	2908-2102	\$2,992.75	3008-2102	\$4,040.22
	24 x 24	2808-2402	\$3,947.78	2908-2402	\$4,720.49	3008-2402	\$6,372.65
	27 x 27	2808-2702	\$5,493.31	2908-2702	\$7,894.59	3008-2702	\$10,657.70
	30 x 30			6408-3002	Call		
	36 x 36			6408-3602	Call		
	Vanstone Flange x Gasket PIP						
 6" - 24" Class 150 Bolt Hole Pattern 30" - 36" Class 25 Bolt Hole Pattern	6 x 6	2953-06042	\$116.73				
	8 x 8	2953-08042	\$171.33				
	10 x 10	2953-10042	\$253.34				
	12 x 12	2953-12042	\$380.25				
	14 x 15.3	2953-14042	\$864.94				
	16 x 15.3	2953-16042	\$918.97				
	18 x 18.7	2953-18742	\$1,425.74				
	20 x 21	2953-20042	\$2,186.91				
	24 x 24	2953-24042	\$3,175.19				
	30	6553-30042	Call				
36	6553-36042	Call					
Vanstone Flange x Spigot PIP							
 6" - 24" Class 150 Bolt Hole Pattern 30" - 36" Class 25 Bolt Hole Pattern	6 x 6	2953-06043	\$116.73				
	8 x 8	2953-08043	\$171.33				
	10 x 10	2953-10043	\$253.34				
	12 x 12	2953-12043	\$380.25				
	14 x 15.3	2953-14043	\$864.94				
	16 x 15.3	2953-16043	\$918.97				
	18 x 18.7	2953-18743	\$1,425.74				
	20 x 21	2953-20043	\$2,186.91				
	24 x 24	2953-24043	\$3,175.19				
	30	6553-30043	Call				
36	6553-36043	Call					

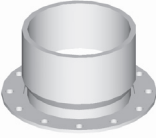

PIP 80, 100 & 125 Gasketed

Item:	Size:	Part Number:	List Price:	Part Number:	List Price:	Part Number:	List Price:
Vanstone Flange x Soc PIP							
 6"-24" Class 150 Bolt Hole Pattern	6 x 6	2953-06041	\$88.59				
	8 x 8	2953-08041	\$134.09				
	10 x 10	2953-10041	\$188.54				
	12 x 12	2953-12041	\$287.92				
	14 x 15.3	2953-14041	\$771.37				
	16 x 15.3	2953-16041	\$779.48				
	18 x 18.7	2953-18741	\$1,261.46				
	20 x 21	2953-20041	\$1,921.49				
	24 x 24	2953-24041	\$2,813.93				
	30"-36" Class 25 Bolt Hole Pattern	30	6553-30041	Call			
	36	6553-36041	Call				

Van Stone Flange Bolt Tightening Sequence

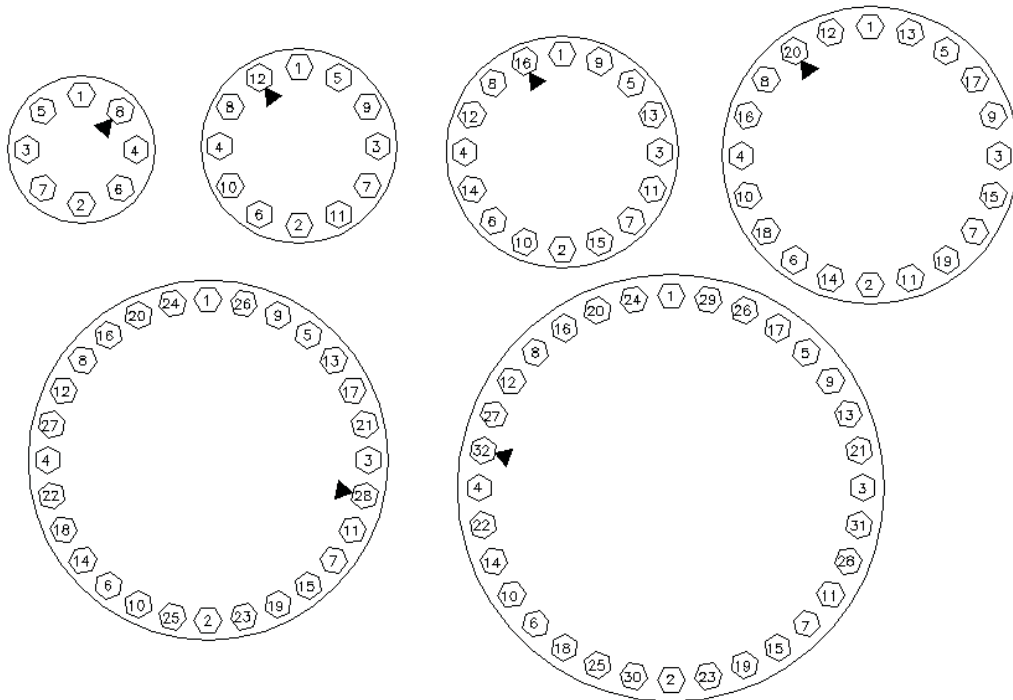







Size	Number of Bolts	Flange Thickness
4	8	1 3/16
6	8	1 5/16
8	8	1 13/32
10	12	1 1/2
12	12	1 5/8
14	12	1/2
16	16	1/2
18	16	1/2
20	20	1/2
24	20	1/2
30	28	1/2
36	32	1/2

4" - 12" Flange Rings are Injection Molded
Fiberglass Reinforced (FRP)

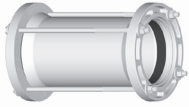
14" - 36" Flange Rings are 1/2" Thick Steel

*Stainless Steel Flange Rings 14" - 36" are available. Call for Pricing.

PIP 80, 100 & 125 Gasketed

Item:	Size:	Part Number:	List Price:	Item:	Size:	Part Number:	List Price:
Bolted Repair Coupler - 100 PSI - 12" Length - Zinc Plated Bolts				Bolted Repair Coupler - 100 PSI - 18" Length - Zinc Plated Bolts			
	6	2928-060	\$106.52		6	2929-060	\$121.80
	8	2928-080	\$133.22		8	2929-080	\$151.03
	10	2928-100	\$160.57		10	2929-100	\$210.47
	12	2928-120	\$184.92		12	2929-120	\$219.83
	14	2928-140	\$475.08		15	2929-150	\$383.54
	15	2928-150	\$335.75				
Bolted Repair Coupler Stainless Steel Bolt Packs				Bolted Repair Coupler Stainless Steel Bolt Packs			
	12" Lengths				18" Lengths		
	6 & 8	65300114-	\$113.55		6 & 8	65300118-	\$147.06
	10	65300115-	\$141.93		10	65300119-	\$183.81
	12	65300116-	\$170.31		12	65300120-	\$220.57
	14	65300117-	\$204.37		15	65300121-	\$264.68
	15	65300117-	\$204.37				
Bolted Repair Coupler Flange Rings PIP				Bolted Repair Coupler Gaskets PIP			
 *Machined, not molded	6	15180058-	\$26.64		6	15180002-	Call
	8	15180059-	\$32.33		8	15180006-	Call
	10	15180060-	\$38.51		10	15180010-	Call
	12	15180061-	\$53.00		12	15180014-	Call
	14*	15180019-	\$217.00		14	15180018-	Call
	15	15180062-	\$64.50		15	15180022-	Call

- 6" & 8" - 4 bolts
- 10" - 5 bolts
- 12" - 6 bolts
- 14" & 15" - 7 bolts

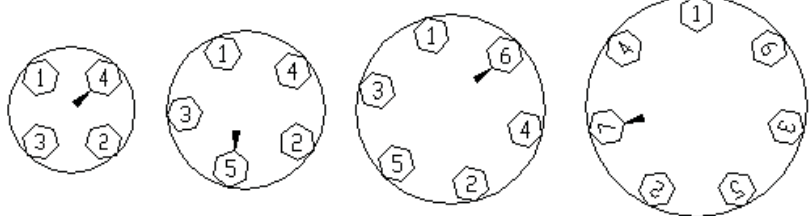

Bolted Couplers are shipped assembled and boxed individually.

NACO Industries Bolted Compression Couplers with *Injection Molded* Fiberglass Reinforced PVC Flange Ends.

Exceptional Corrosion Resistance -

Combine *injection molded fiberglass reinforced PVC flanges*, *PVC body*, and *Buna-S gaskets* and you have a superior product that **will not pit, rust, or scale**; which is common to metal compression couplers.

